

# K-BUS<sup>®</sup> Line Coupler

## User manual-Ver.1

BNLC-00/00.1

**KNX/EIB Intelligent Installation Systems**



## Contents

---

<b>1. Summary</b>	<b>3</b>
<b>2. Technical Properties, Dimension and Display &amp; Operator elements</b>	<b>4</b>
2.1 Technical data	4
2.2 Dimension diagram	6
2.3 Function of Display and Operator elements	6
<b>3. Application Description Coupler</b>	<b>8</b>
3.1 Coupler	8
3.2 Repeater	8
<b>4. Parameter setting description in the ETS</b>	<b>9</b>
4.1 Coupler	9
4.1.1 Setting	9
4.1.2 Parameter window “General”	9
4.1.3 Parameter window “Main Line”	10
4.1.4 Parameter window “Sub Line”	13
4.2 Repeater	16
4.2.1 Setting	16
4.2.2 Parameter window “General”	16
4.2.3 Parameter window “Main Line”	18
4.2.4 Parameter window “Sub Line”	20

## 1. Summary

The coupler can be used as line coupler, backbone coupler or repeater as well in existing EIB networks as in new KNX EIB networks. It has a filter table with the help of which bus telegrams are either blocked off from one of the two lines or are passed on to another line thus reducing the bus load. The filter table is created by the ETS (EIB Tool Software) automatically on commissioning the system.

As there are no differences in hardware between the line coupler, the backbone coupler and the repeater they were given the same ordering number.

The power supply of the coupler electronics occurs via the connection to the main line.

Used as a line coupler, The basic functionality of the coupler is coupling a KNX-TP-main line with a KNX-TP-sub line. The coupler provides galvanic isolation between the two connected lines. Due to the flexibility of the coupler, it can be used as a line coupler to connect a line to a main line or as a backbone coupler to connect a main line to a backbone line. The main task of the coupler is filtering the traffic according the installation place in the hierarchy or according to the built in filter tables for group oriented communication. The the coupler provides outstanding features compared to other similar products, for example support for long messages (up to 250 byte length) and a configurable one button activation of special functions (e.g. transmit all group telegrams). These are helpful during installation, during run time and for trouble shooting. The high informative 6 duo LED display shows accurate the bus status on each line. This helps identifying common communication problems due to bus load or re-transmissions on both lines.

Used as a repeater, its function has the target to link two lines for data transfer. And it still provides galvanic isolation between the connected lines. Up to three line repeaters can be used behind a line coupler. As a result, up to four lines can form a complete line. Each line must be supplied by a dedicated KNX power supply.

This manual provides the technical information about the coupler as well as assembly and programming in detail for users, and explains how to use the coupler by the application examples.

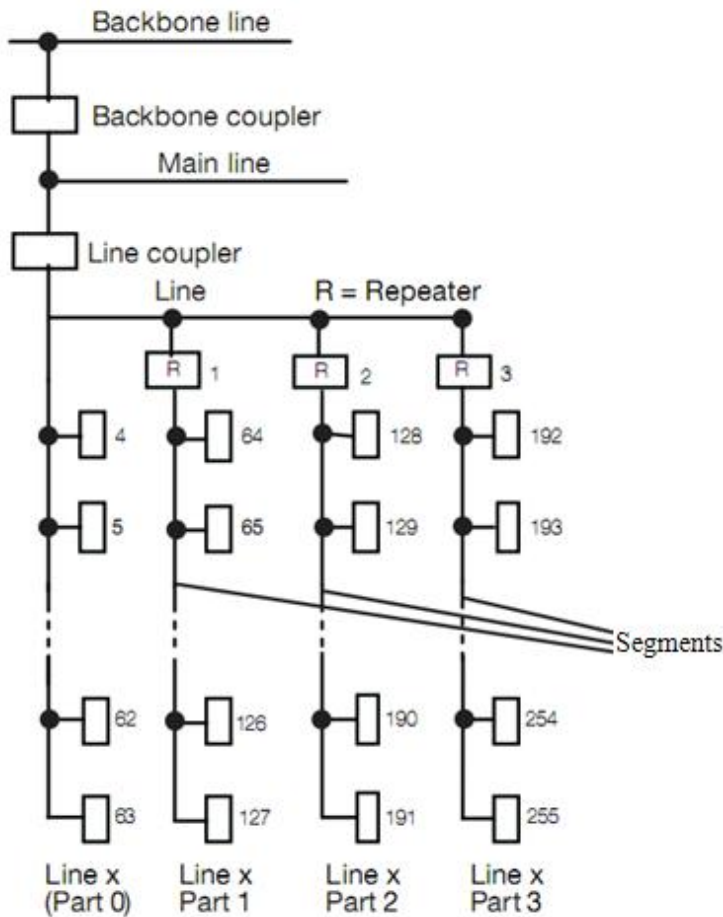

Fig.1. Connection of repeaters to a bus line

Application Programs :

The coupler can be programmed with the ETS up from version ETS2V11. Used as a line/backbone coupler the application program “Coupler” and used as a repeater the application program “Repeater” has to be downloaded.

Please note that commissioning straight at delivery status means:

- The line coupler does block all telegrams because the filter table is not defined,
- The fallback time after manual operation is 120 min and
- The physical address is 15.15.0.

## 2. Technical Properties, Dimension and Display & Operator elements

### 2.1 Technical data

<b>Power supply</b>	Primary line	21-30V DC, used for power supply of the device
	Secondary line	21-30V DC
	Current consumption from Bus	approx. 30mA
<b>Connections</b>	EIB ,primary line	Left bus connection terminal
	EIB, secondary line	Right bus connection terminal
<b>Operating and display</b>	LED Bus State Main green	Off: main line error On: main line ok
	LED Bus State Main red	On: manual overwrite active
	LED Bus State Sub green	Off: sub line error or not connected On: sub line ok
	LED Traffic Main green	Telegram traffic on the primary line(main line)
	LED Traffic Sub green	Telegram traffic on the secondary line (line)
	LED Traffic Main red	Blinking: transmission error on main line
	LED Traffic Sub red	Blinking: transmission error on sub line
	LED Group Address	Routing of group telegrams
	LED Physical Address	Routing of physical addressed telegrams
	Programming button and LED	For assignment of the physical address
	Function button	Switch to manual override
<b>Temperature</b>	Operation	-5 °C ... + 45 °C
	Storage	-25 °C ... + 55 °C
	Transport	- 25 °C ... + 70 °C
<b>Design</b>	Modular installation device, on 35mm mounting rail	
<b>Relative humidity:</b>	5% to 93% (non-condensing)	
<b>Dimensions</b>	90 mm×36 mm×70mm	
<b>Weight</b>	0.1KG	
<b>Housing,</b>	Plastic PA66 housing grey	
<b>Protection</b>	IP 20, to EN 60529	
<b>CE mark</b>	in accordance with EMC and low voltage guidelines	
	Device complies with EN 60669-2-1 and EN 50491-5-3 / EN 61000-6-2	
<b>Markings</b>	KNX/EIB	

## 2.2 Dimension diagram

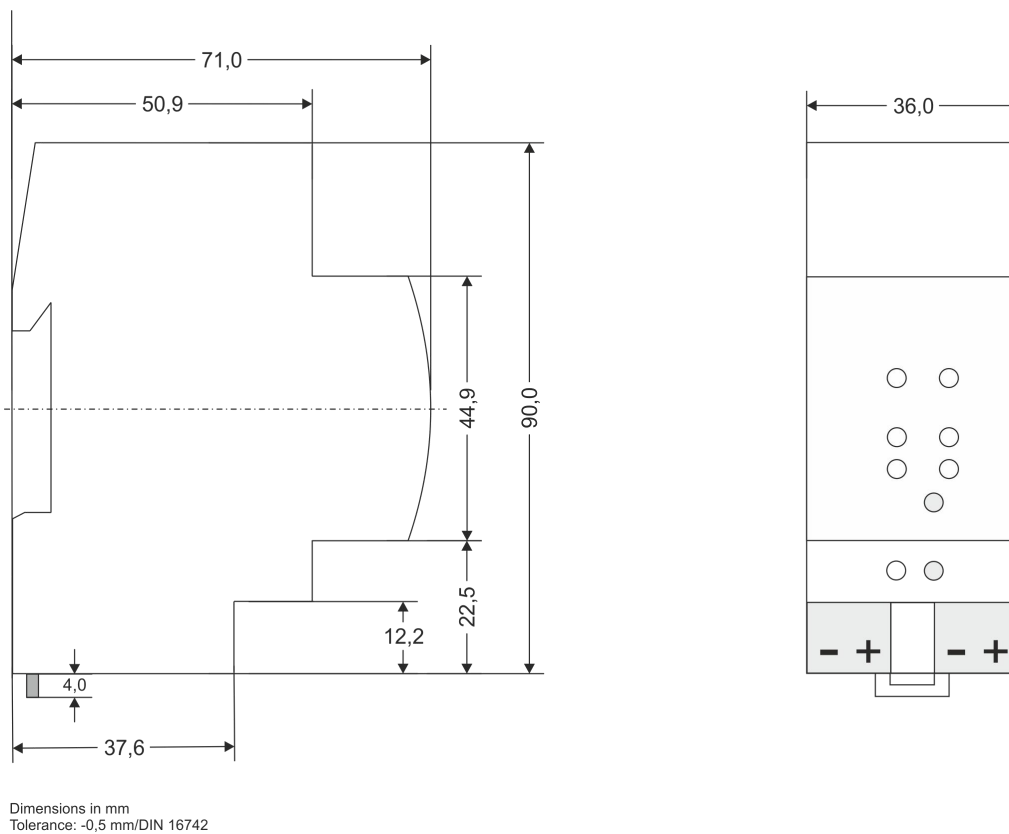

1 SU = 18mm

## 2.3 Function of Display and Operator elements

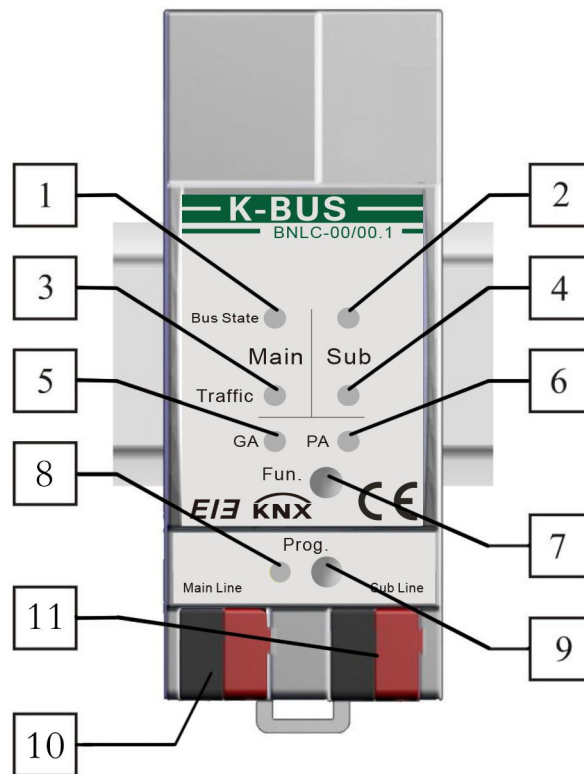

LEDs Bus State, Traffic and GA are green or red.

LED PA is green or yellow.

1. LED Bus State Main-- green on: main line ok; green off: main line error; red on: manual overwrite active
2. LED Bus State Sub-- green on: sub line ok; green off: sub line error or not connected
3. LED Traffic Main-- green blinking:bus traffic on main line (blinking only for valid telegrams!); off: no traffic on main line
4. LED Traffic Sub-- green blinking:bus traffic on sub line (blinking only for valid telegrams!); off: no traffic on sub line
5. LED GA (Group Address):Routing of group telegrams; off: main and sub different; green: filter table active; green and red: route all; red: block
6. LED PA (Physical Address): Routing of physical addressed telegrams; off: main and sub different; green: filter table active; green and yellow: route all; yellow: block
7. Function button: Switch to manual override via long operation (3s)
8. Programming LED: Red LED for indicating normal operating mode (LED off) or addressing mode (LED on);  
Upon receiving the physical address the device automatically returns from addressing mode to normal operating mode
9. Programming button: Learning button for switching between normal operating mode and addressing mode for assigning the physical address
10. KNX-Bus connection: Main line
11. KNX-Bus connection: Sub line

**Note:**

*The latest downloaded settings (parameters) and filter table are still available after switching back from “Manual operation” to “Normal operation”.*

*Function button via very long press (15s), LEDs: Bus State Main, Bus State Sub, Group Addr, Physical Addr are on red, release button and press again for some sec: resets all the parameter to factory default (incl. physical address).*

### 3. Application Description Coupler

Application program	Max. number of communication objects	Max. number of group address	Max. number of associations
The line coupler/repeater	0	0	0

#### 3.1 Coupler

If the coupler receives telegrams (for example during commissioning) which use a physical address as destination address, it compares the physical addresses of the receiver with its own physical address and then decides whether it must route the telegrams or not.

The coupler reacts to telegrams with group addresses in accordance with its parameter settings. During normal operation (default setting), the coupler only routes those telegrams whose group addresses have been entered in its filter table.

If the coupler routes a telegram and does not receive an acknowledgement, or if a bus device finds a transmission error, the coupler repeats the telegram three times. With the parameters “Repetitions if errors...”, this behaviour can be set separately for both lines. These parameters should be left in the default setting.

#### 3.2 Repeater

Line repeaters do not have any filter tables. This means that a telegram is sent to all lines irrespective of whether it is processed in the corresponding line. It is therefore not important whether the telegram has been triggered within the lines or whether it has been sent from the main line to the lines via the line coupler.

If an error occurs during the transmission of a telegram with the physical address of a receiver, the line repeater can repeat the telegram. This behaviour can be set separately for both line segments with the parameters „ Physical: Repetition if errors on main line/on sub line“.

If the line repeater routes a group telegram and does not receive an acknowledgement, or if a bus device finds a transmission error, the line repeater repeats the telegram three times. With the parameters „Group: Repetition if errors on main line/on sub line“, this behaviour can be set separately for main line and sub line.



## 4. Parameter setting description in the ETS

### 4.1 Coupler

#### 4.1.1 Setting

If not already configured as “coupler”, the corresponding application program for “coupler” should be downloaded.

Change can occur under “Change Application Program...” and could be checked under “Properties”:

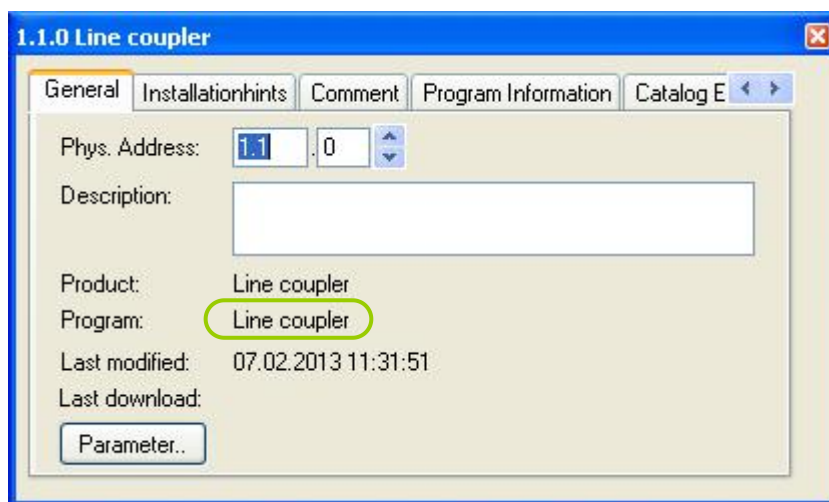

#### 4.1.2 Parameter window “General”

Parameter window is shown as follow:

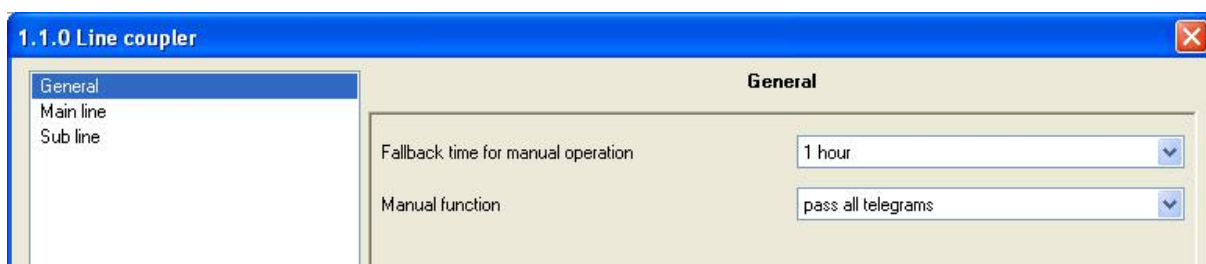

Fig.4.1: parameter window “General”

#### Parameter “Fallback time for manual operation”

Time duration required to exit from “manual operation”. Options:

10 min

1 hour

4 hours

8 hours

**Parameter “Manual function”**

Telegram routing configuration for the manual function. Options:

Disabled

Pass all telegrams

Pass physical telegrams

Pass group telegrams

Please note that the parameter “transmit all” for Group or Physical telegrams is intended only for testing purposes and it should not be set for normal operation.

**4.1.3 Parameter window “Main Line”**

Fig.4.2: parameter window “Main line”

**Parameter “Configuration”**

This parameter is to be set depending on the planned configuration. Options:

groups: filter, physical: block

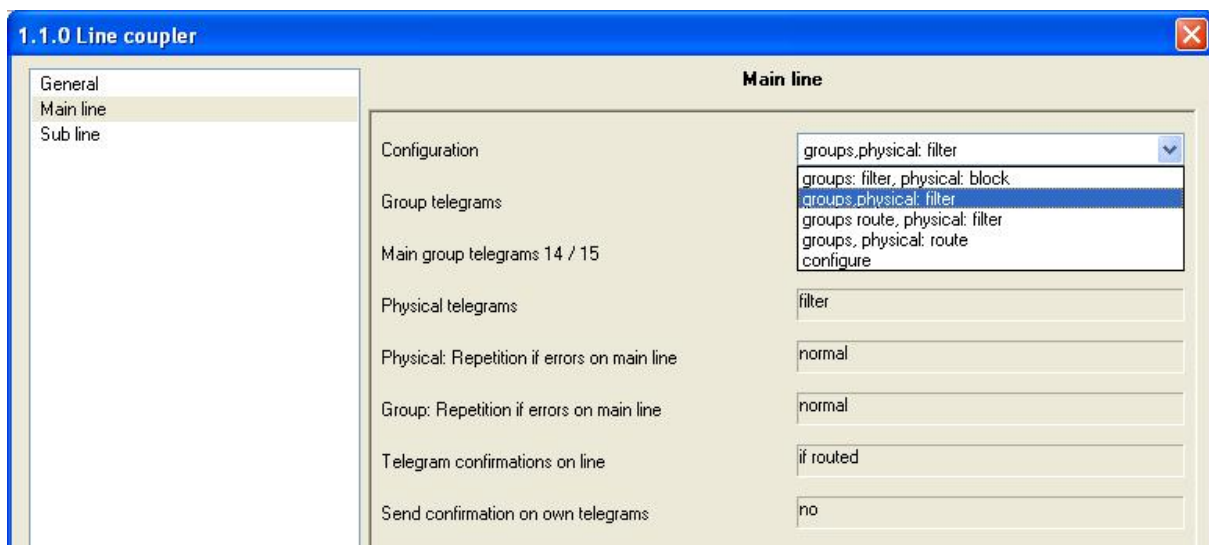
groups, physical: filter

groups: route, physical: filter

groups, physical: route

configure

Block: no telegram is routed.

Filter: Only telegrams are routed which are entered in the filter table.

Route: the telegrams are routed.

Configure: the following parameters can be set individually.

#### **Parameter “Group telegrams”**

Options:

transmit all (for testing only)

block

filter

Transmit all: All group telegrams are transmitted.

Block: No group telegram is transmitted.

Filter: Only group telegrams are routed which are entered in the filter table. The ETS 3/4 produces the filter table automatically.

#### **Parameter “Main group telegrams 14/15”**

Options:

transmit all

block

Transmit all: Group telegrams with the main group 14 or 15 (e.g. 14/1) are routed.

Block: Group telegrams with the main group 14 or 15 (e.g. 14/1) are not routed.

#### **Parameter “Physical telegrams”**

Options:

transmit all (for testing only)

block

filter

Transmit all: All physical telegrams are transmitted.

Block: No physical telegram is transmitted.

Filter: Only physical telegrams are routed based on physical address.

#### **Parameter “Physical: Repetition if errors on main line”**

Options:

no

normal

reduced

If a transmission error (e.g. due to missing receiver) is found when sending a physical telegram on the main line:

No: The physical telegram is not repeated.

Normal: The physical telegram is repeated up to 3 times.

Reduced: The physical telegram will be repeated only one time.

#### **Parameter “Group: Repetition if errors on main line”**

Options:

no

normal

reduced

If a transmission error (e.g. due to missing receiver) is found when sending a group telegram on the main line:

No: The group telegram is not repeated.

Normal: The group telegram is repeated up to 3 times.

Reduced: The group telegram will be repeated only one time.

#### **Parameter “Telegram confirmations on line”**

Options:

if routed

always

If routed: Only telegrams which are to be routed are confirmed on the main line (ACK).

Always: Each telegram on the main line is confirmed (ACK).

#### Parameter “Send confirmation on own telegrams”

Options:

yes

no

Yes: Every telegram on the main line is confirmed with its own ACK (from the Line coupler).

No: No confirmation with own ACK

#### NOTE:

*If the parameter “Send confirmation on own telegrams” is set yes, the line coupler will send an ACK systematically when sending any own routed telegram.*

#### 4.1.4 Parameter window “Sub Line”

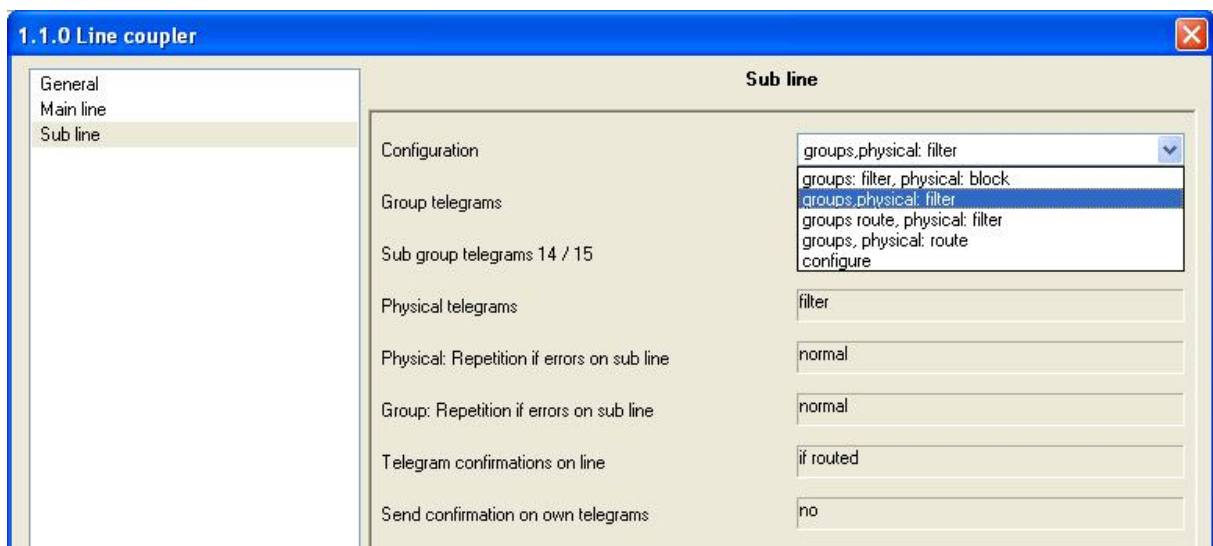

Fig.4.3: parameter window “Sub line”

#### Parameter “Configuration”

This parameter is to be set depending on the planned configuration. Options:

groups: filter, physical: block

groups, physical: filter

groups: route, physical: filter

groups, physical: route

configure

Block: no telegram is routed.

Filter: Only telegrams are routed which are entered in the filter table.

Route: the telegrams are routed.

Configure: the following parameters can be set individually.

### **Parameter “Group telegrams”**

Options:

transmit all (for testing only)

block

filter

Transmit all: All group telegrams are transmitted.

Block: No group telegram is transmitted.

Filter: Only group telegrams are routed which are entered in the filter table. The ETS 3/4 produces the filter table automatically.

### **Parameter “Sub group telegrams 14/15”**

Options:

transmit all

block

Transmit all: Group telegrams with the sub group 14 or 15 (e.g. 14/1) are routed.

Block: Group telegrams with the sub group 14 or 15 (e.g. 14/1) are not routed.

### **Parameter “Physical telegrams”**

Options:

transmit all (for testing only)

block

filter

Transmit all: All physical telegrams are transmitted.

Block: No physical telegram is transmitted.

Filter: Only physical telegrams are routed based on physical address.

#### **Parameter “Physical: Repetition if errors on sub line”**

Options:

no

normal

reduced

If a transmission error (e.g. due to missing receiver) is found when sending a physical telegram on the sub line:

No: The physical telegram is not repeated.

Normal: The physical telegram is repeated up to 3 times.

Reduced: The physical telegram will be repeated only one time.

#### **Parameter “Group: Repetition if errors on sub line”**

Options:

no

normal

reduced

If a transmission error (e.g. due to missing receiver) is found when sending a group telegram on the sub line:

No: The group telegram is not repeated.

Normal: The group telegram is repeated up to 3 times.

Reduced: The group telegram will be repeated only one time.

#### **Parameter “Telegram confirmations on line”**

Options:

if routed

always

If routed: Only telegrams which are to be routed are confirmed on the sub line (ACK).

Always: Each telegram on the sub line is confirmed (ACK).

#### Parameter “Send confirmation on own telegrams”

Options:

yes

no

Yes: Every telegram on the sub line is confirmed with its own ACK (from the Line coupler).

No: No confirmation with own ACK

## 4.2 Repeater

### 4.2.1 Setting

If not already configured as “repeater”, the corresponding application program for “repeater” should be downloaded.

Change can occur under “Change Application Program...” and could be checked under “Properties” :

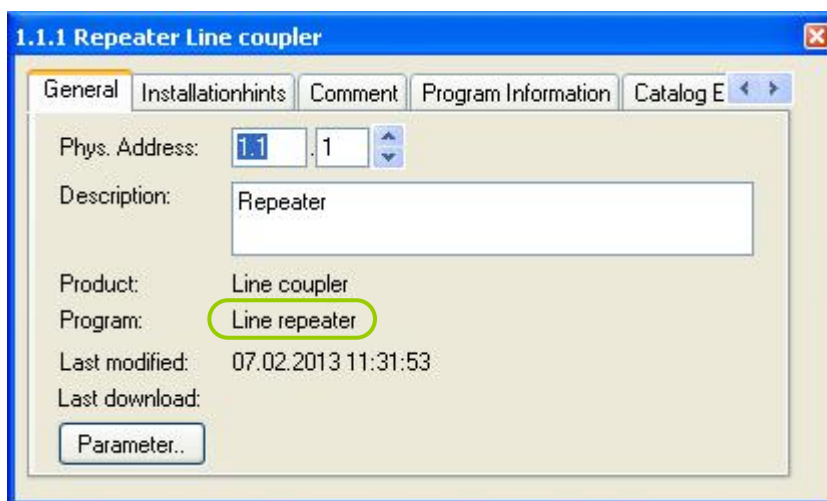

### 4.2.2 Parameter window “General”

Parameter window is shown as follow:



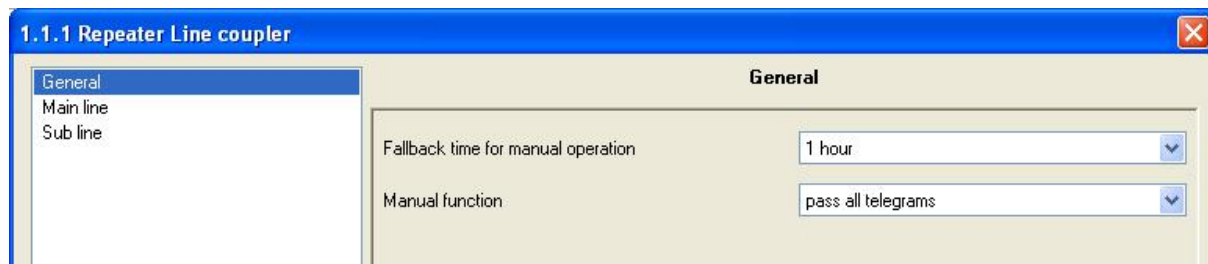

Fig.4.4: parameter window "General"

**Parameter "Fallback time for manual operation"**

Time duration required to exit from "manual operation". Options:

- 10 min
- 1 hour
- 4 hours
- 8 hours

**Parameter "Manual function"**

Telegram routing configuration for the manual function. Options:

- Disabled
- Pass all telegrams
- Pass physical telegrams
- Pass group telegrams

Please note that the parameter "transmit all" for Group or Physical telegrams is intended only for testing purposes and it should not be set for normal operation.

### 4.2.3 Parameter window “Main Line”

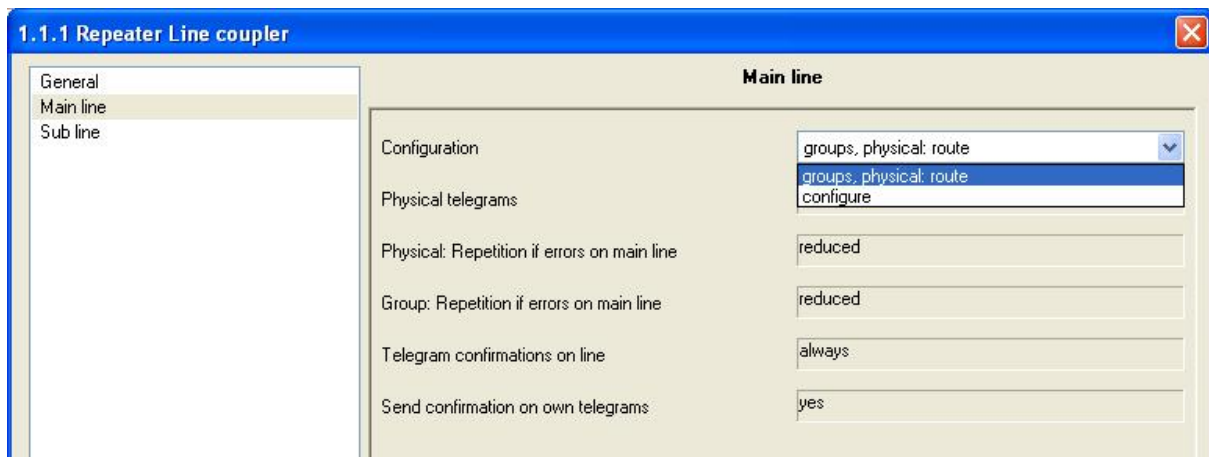

Fig.4.5: parameter window “Main line”

#### Parameter “Configuration”

This parameter is to be set depending on the planned configuration. Options:

groups, physical: route

configure

Route: the telegrams are routed.

Configure: the following parameters can be set individually.

#### Parameter “Physical telegrams”

Options:

transmit all

block

Transmit all: All physical telegrams are transmitted.

Block: No physical telegram is transmitted.

#### Parameter “Physical: Repetition if errors on main line”

Options:

no

normal

reduced

If a transmission error (e.g. due to missing receiver) is found when sending a physical telegram on the main line:

No: The physical telegram is not repeated.

Normal: The physical telegram is repeated up to 3 times.

Reduced: The physical telegram will be repeated only one time.

**Parameter “Group: Repetition if errors on main line”**

Options:

no

normal

reduced

If a transmission error (e.g. due to missing receiver) is found when sending a group telegram on the main line:

No: The group telegram is not repeated.

Normal: The group telegram is repeated up to 3 times.

Reduced: The group telegram will be repeated only one time.

**Parameter “Telegram confirmations on line”**

Options:

if routed

always

If routed: Only telegrams which are to be routed are confirmed on the main line (ACK).

Always: Each telegram on the main line is confirmed (ACK).

**Parameter “Send confirmation on own telegrams”**

Options:

yes

no

Yes: Every telegram on the main line is confirmed with its own ACK (from the Line coupler).

No: No confirmation with own ACK

**NOTE:**

*If the parameter “Send confirmation on own telegrams” is set yes, the repeater will send an ACK systematically when sending any own routed telegram.*

*Since the repeater has no filter table, it makes sense to send an ACK with every routed telegram.*

**4.2.4 Parameter window “Sub Line”**

Fig.4.6: parameter window “Sub line”

**Parameter “Configuration”**

This parameter is to be set depending on the planned configuration. Options:

groups, physical: route

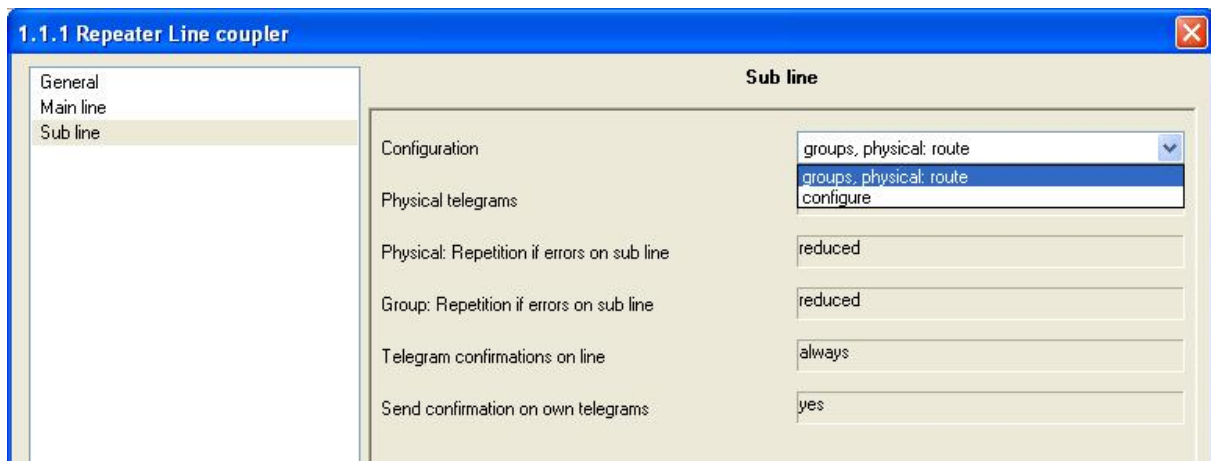
configure

Route: the telegrams are routed.

Configure: the following parameters can be set individually.

**Parameter “Physical telegrams”**

Options:

transmit all

block

Transmit all: All physical telegrams are transmitted.

Block: No physical telegram is transmitted.

**Parameter “Physical: Repetition if errors on sub line”**

Options:

no

normal

reduced

If a transmission error (e.g. due to missing receiver) is found when sending a physical telegram on the sub line:

No: The physical telegram is not repeated.

Normal: The physical telegram is repeated up to 3 times.

Reduced: The physical telegram will be repeated only one time.

**Parameter “Group: Repetition if errors on sub line”**

Options:

no

normal

reduced

If a transmission error (e.g. due to missing receiver) is found when sending a group telegram on the sub line:

No: The group telegram is not repeated.

Normal: The group telegram is repeated up to 3 times.

Reduced: The group telegram will be repeated only one time.

**Parameter “Telegram confirmations on line”**

Options:

if routed

always

If routed: Only telegrams which are to be routed are confirmed on the sub line (ACK).

Always: Each telegram on the sub line is confirmed (ACK).

**Parameter “Send confirmation on own telegrams”**

Options:

yes

no

Yes: Every telegram on the sub line is confirmed with its own ACK (from the Line coupler).

No: No confirmation with own ACK